

STEICO Building System

Product Information

Construction elements – naturally made of timber

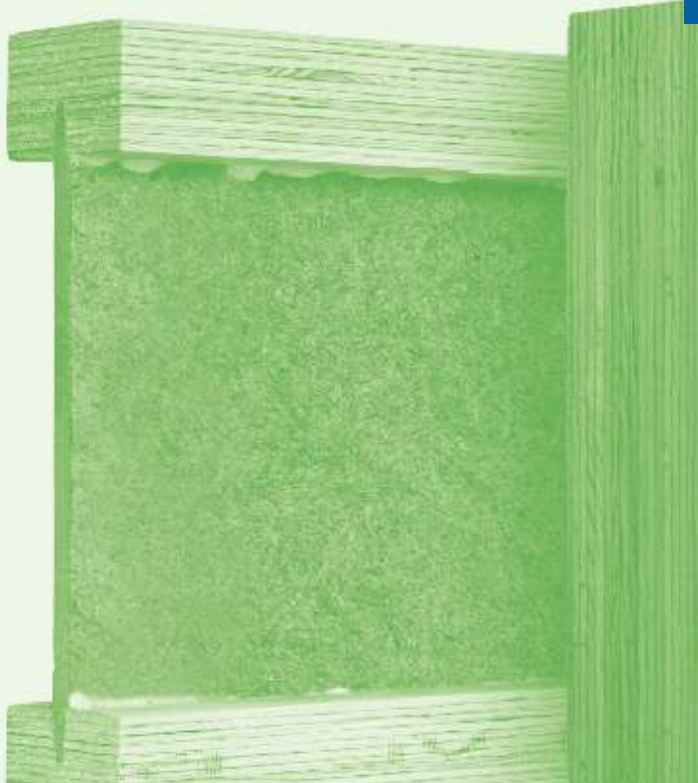

| AREAS OF USE

I-Joists for floor joists, rafters or wall studs.

Laminated Veneer Lumber for joists, beams, studs, purlins, header and sole plates, lintels and structural panels.

- High load bearing capacity, long spans
- High dimensional stability
- Excellent manufacturing tolerances
- Compatible with existing timber sizes and connection methods
- High strength to weight ratio
- Reduced settlement
- Integrated construction and insulation system
- Efficient use of timber resources

For more information please visit our website at www.steico.co.uk



Following natures lead

STEICO construction products combine high load bearing capacity with the highest efficiency.

Nature shows us the way by producing slender constructions with maximum stability. The functional principles are simple: Reduction. Where no material is required then no material is wasted. The Result: Improved material properties with low weight and low primary energy consumption whilst providing the highest energy efficiency. The STEICO building system follows these principles.



The STEICO Building System with STEICOjoist, STEICOwall and STEICO LVL are certified as Passive House components by the Passive House Institute.

STEICOjoists are especially lightweight, energy efficient elements that uses a slender web material from natural fibreboard to connect the two flanges. The flanges are made of laminated veneer lumber STEICO LVL R. This guarantees consistently high quality and defined strengths.

STEICO LVL consists of several layers of bonded softwood veneers. This structure gives STEICO LVL its high strength. Laminated veneer lumber is one of the most resilient timber construction materials available.

STEICO Product overview

Individual components

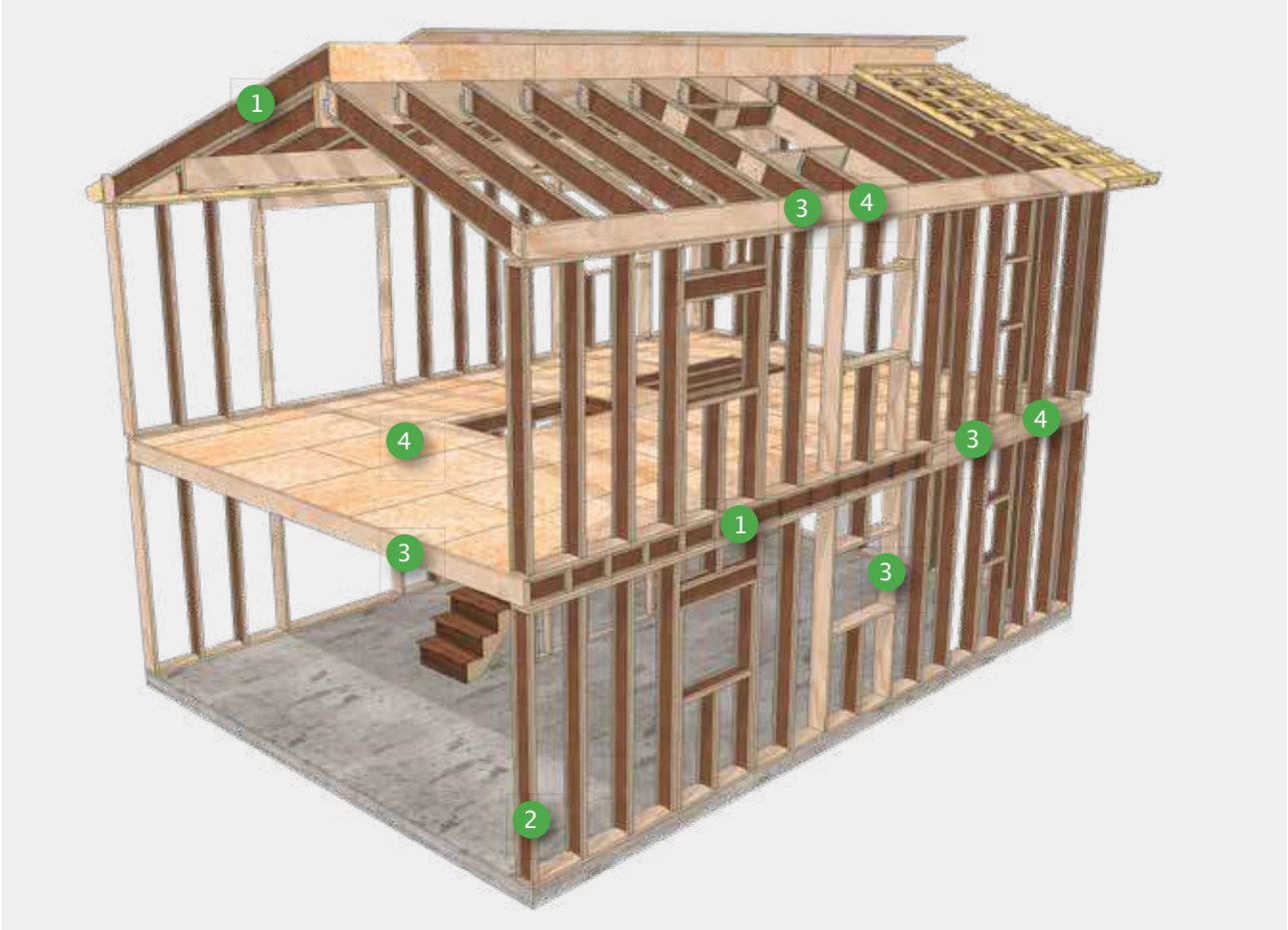

STEICO I-joists

STEICO Laminated Veneer Lumber

			
STEICOjoist	STEICOWall	STEICO LVL R	STEICO LVL X
I-joist to European Technical Approval ETA-06/0238	I-joist to European Technical Approval ETA-06/0238	CE certified and manufactured to EN 14374	CE certified and manufactured to EN 14374
For use as floor joists, rafters or wall studs	For use as wall studs or facades	Laminated Veneer Lumber for joists, beams, studs, purlins, rimboard	Laminated Veneer Lumber for structural panels, rimboard, headers and sole plates
CE	CE	CE	CE

Product overview individual components: STEICO I-joists

STEICOjoist/STEICOWall

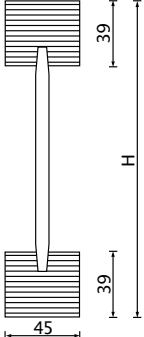
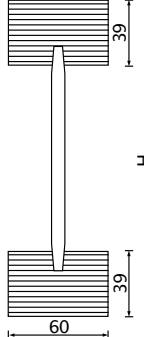
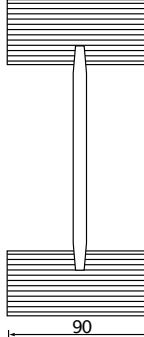
STEICOjoist SJ _L 45	STEICOjoist SJ _L 60	STEICOjoist SJ _L 90
 <p>200 220 240 300 360 400</p>	 <p>200 220 240 300 360 400 450 500</p>	 <p>200 220 240 300 360 400 450 500</p>
Package =43 pieces/package	Package =33 pieces/package	Package =23 pieces/package

STEICOjoist

E-Joist Building System for floors& roofs

The ideal joist for highly loaded structural elements like rafters or floor joists.

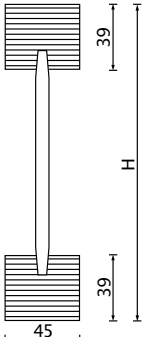
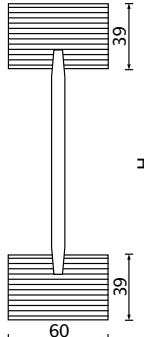
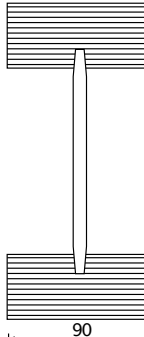

STEICOWall SW _L 45	STEICOWall SW _L 60	STEICOWall SW _L 90
 <p>160 200 240 300 360</p>	 <p>160 200 240 300 360 400 500</p>	 <p>200 240 300 360 400 500</p>
Package =43 pieces/package	Package =33 pieces/package	Package =23 pieces/package

STEICOWall

E-Joist Building System for walls

The optimum member for axially loaded components such as wall studs or spacers in platform construction and roof insulation.

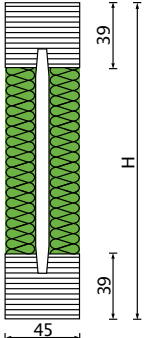
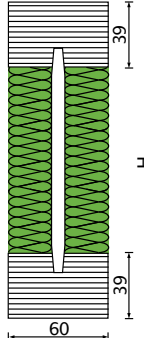
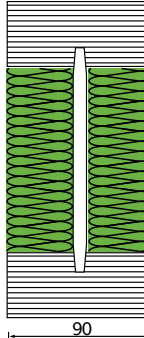

Pre-Insulated joist - All I-joists are available with a pre insulated web

 <p>160 200 240 300 360 400</p>	 <p>160 200 240 300 360 400 500</p>	 <p>200 240 300 360 400 500</p>
Package =26 pieces/package	Package =19 pieces/package	Package =13 pieces/package

The factory applied web insulation ensures a uniform rectangular cross section. This allows efficient insulation with the flexible insulation batt STEICOflex.



Standard length: 9.0 / 10.0 / 11.0 / 12.0 / 13.0m; Additional lengths and cuts available on request
 Example SJ_L 45: S=STEICO, J=joist, L=Laminated Veneer Lumber flange, 45=width of the flange in mm

Product overview STEICO LVL

STEICO LVL – Laminated Veneer Lumber

STEICO LVL is made of multiple 3 mm layers of graded laminated veneers. This disperses knots and irregular growth, producing a practically homogenous cross-section. This construction means that STEICO LVL is highly rigid and dimensionally stable.

STEICO LVL R Laminated Veneer Lumber

Powerful engineered timber product for rectangular cross-sections. With STEICO LVL R elements all veneer layers are glued together longitudinally.

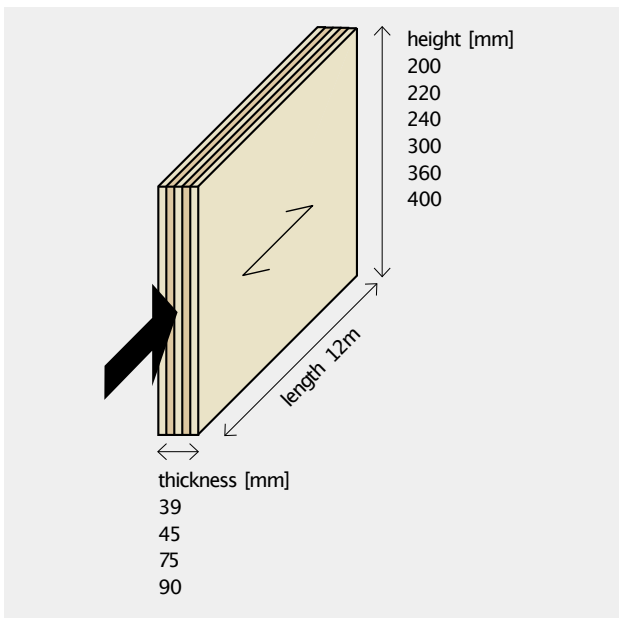

STEICO LVL X Laminated Veneer Lumber with cross-layers

Cross laminated STEICO LVL X means that ca. one-fifth of the veneers are glued crosswise – improving the lateral bending strength and stiffness of the joist.

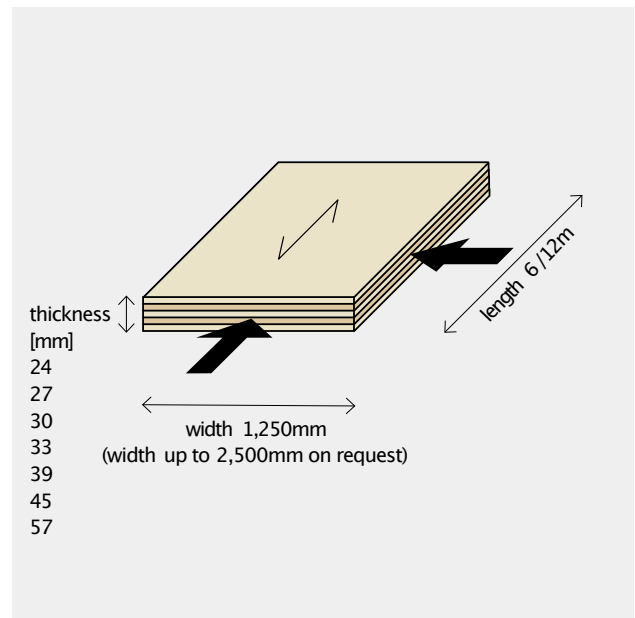

STEICO LVL R used for the construction of high load bearing floor structures



STEICO LVL X as a stiffening decking element for pre-assembled floor cassettes

Advantages of the STEICO Building System

Reduced thermal bridging	Improvement of base U-value levels by up to 15%. – Reduction of low surface level temperatures
High load bearing capacity with low self-weight	Up to 3 times the weight saving
Pre-Insulated option	Factory insulated joists ensure uniform rectangular cross-section
Easy installation of services	Services can be run through holes in I-joist web
Defined moisture content close to the material norm (8–12%)	Reduces swelling and shrinkage dimensions
Usage of dimensionally stable materials	Reduction in dimensional changes by up to 90% with changes in moisture when compared to solid timber.
Cuts	Cuts available on request
Resource saving by using timber as a raw material	Timber is only used where it is required.
Usage of homogenous materials	Defined material stability and hence material reduction
Compatible components	Compatible material thickness with STEICOflex or STEICOzell STEICO LVL sizes in line with STEICOjoist
Usage of renewable materials	STEICO products with FSC® and PEFC® certification ensure responsible forest stewardship.
Fire protection	Testing constructions up to F90-B available
Certified quality	Both the STEICOjoist and STEICO LVL are CE certified. Production is supervised by independent 3rd parties.
Design software	STEICO offers single member and full design software packages for STEICOjoist and STEICO LVL. Please contact us.
Passive House certification	The STEICO Building System with STEICOjoist, STEICOwall and STEICO LVL are certified as Passive House components by the Passive House Institute.



Reduce thermal bridges



Light and easy to handle, perfect for use in conversion projects and sites with limited access



Usual rectangular section with web insulation



Easier Installation of building technology



Precise manufacturing tolerances



Can be processed using standard wood processing machines



Environmentally friendly and recyclable



Great bearing strength, large spans and stiffness enabling long spans



Available in standard joist dimensions and custom depths

Production is monitored internally and external in order to ensure consistent product quality. The STEICO I-joists are approved under ETA-06/0238.



Optimised building fabric

External wall construction



Build up from inside to outside

- 1 Plasterboard
- 2 Structural timber board
- 3 STEICOWall with STEICOzell air-injected wood fibre insulation
- 4 STEICOprotect H external render board
- 5 Render system

Advantages of the system

- Only 5 elements to make an ecological vapour open system
- Robust external wood fibre insulation system
- Vapour open - no additional vcl required
- High specific heat capacity of the external wood fibre board - warm wall surface hence less risk of algae or mold
- Produced from renewable material
- Dimensional stability
- U values can be adjusted by varying the joist depth with minimal effect on cost.
- Defined material moisture content
- Fire certification up to F 90-B/REI 90 available

Roof construction

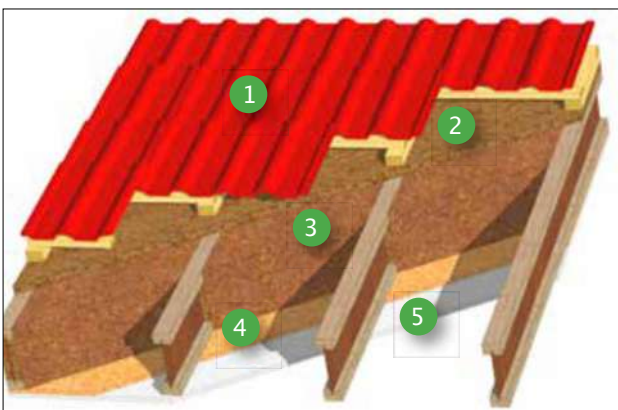

Build up from outside to inside

- 1 Counter batten, tile batten, roof covering
- 2 STEICOuniversal sarking board
- 3 STEICOjoist with STEICOzell air-injected wood fibre insulation
- 4 Vapour control layer with batten
- 5 Plasterboard

Advantages of the system

- Secure STEICOuniversal sarking board
- Vapour open - no additional vcl required
- Excellent summerheat protection due to high specific heat capacity
- Often no purlins require and therefore increased internal room
- Produced from renewable materials
- Fire certification available
- U values can be adjusted by varying the joist depth with minimal effect on cost
- Dimensional stability
- Defined material moisture content

We spend approx. 80% of our lives in enclosed rooms. But are we always aware what we are surrounding ourselves with? STEICO has set itself the target of developing building products which consider the needs of both man and nature. Our products are therefore produced using sustainable natural materials. They help reduce energy use and add considerably to a natural healthy internal climate.

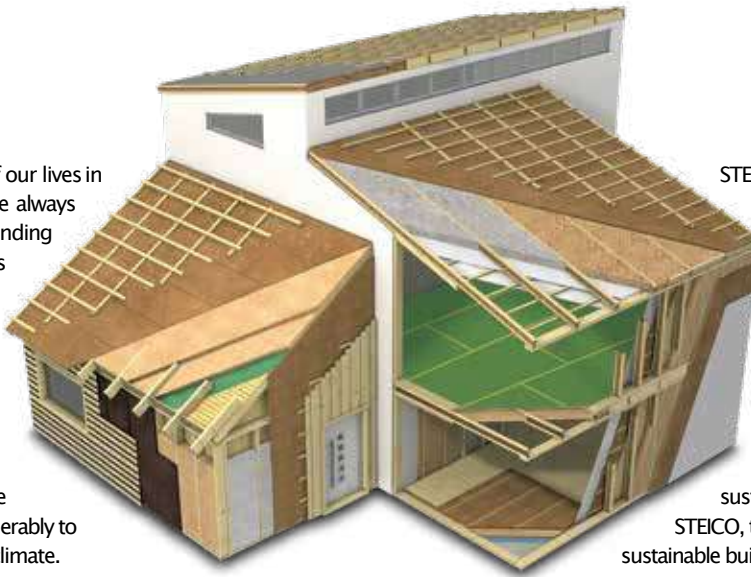

STEICO insulation and construction materials, carry a number of distinguished 'seals of approval' which is a sign of high quality, healthy and functional building products. The raw materials used in STEICO products are certified by FSC® (Forest Stewardship Council®) and PEFC® (Programme for the Endorsement of Forest Certification®), ensuring a traceable and fully sustainable usage of the raw materials. STEICO, the number 1 choice for your sustainable building solutions.

Natural insulation and construction systems for new builds and renovations – roof, ceiling, wall and floor



Renewable raw materials without harmful additives



Excellent cold protection in winter



Excellent summer heat protection



Energy saving and increased property worth



Weather tight and breathable



Excellent Fire Protection



Excellent sound protection



Environmentally friendly and recyclable



Light and easy to handle



Insulation for healthy living



Strong quality control



Compatible insulation and structural building systems



STEICO
engineered by nature

Your STEICO Partner



Sveika statyba
Ekostatybinės medžiagos

Taikos pr. 141C, Kaunas, LT-51132 | www.sveikastatyba.lt | +370 699 96861 | info@sveikastatyba.lt

www.steico.com